

User Guide

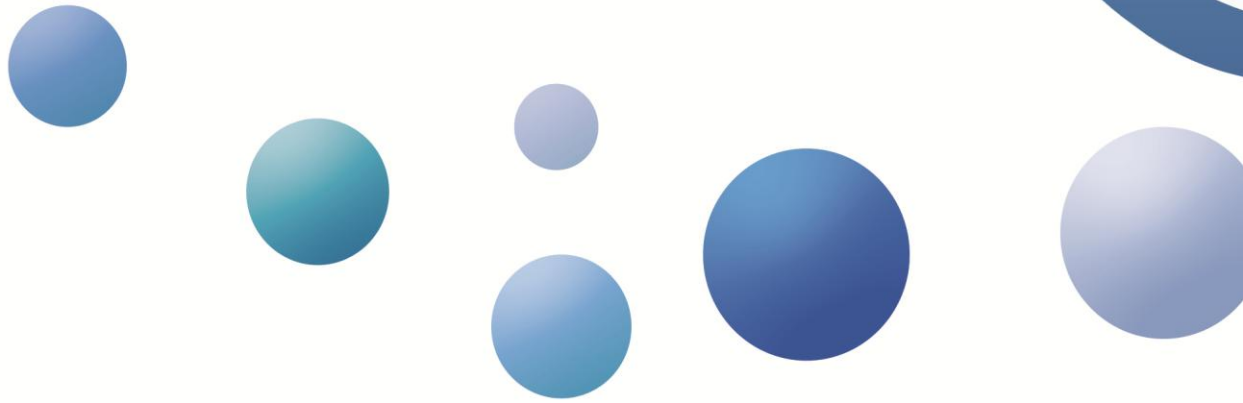

This User Guide Applies to E1007

About This User Guide

Pls read all the content of the user guide carefully to use the products safely and effectively. You are advised of keeping it properly for your using reference.

Disclaimer

Please do not dismantle the product or tear up the seal on it, otherwise we won't provide warranty or replacement service.

The pictures in this user guide are for reference only. If there are any pictures which not match the actual product, please take actual products as the standard. Updated information is subject to change without notice.

All information contained in this guide are protected by copyright, and our company reserves all rights. All or part of this guide is prohibited to excerpt, copy, bundle other products, or sell without the written permission from us.

Version Record

Version number	Version description	Version date
V 1.0.0	Initial version	2016-8-23
V 1.2.3	Optimize menu	2016-9-10
V 1.5.1	Optimize decoding performance	2016-12-01
V 2.0.1	Modify performance menu	2017-03-01
V 2.0.2	Perfect overall performance	2017-07-18

CATALOG

1、Product Introduction	1
1.1 Main feature	1
1.2 Unpack your device	1
1.3.1 External view	错误！未定义书签。
1.4 Communication port	2
1.5 Interface description	2
1.5.1 Scan module interface CMOS	3
1.5.2 Standard serial port (DB9)	3
1.5.3 USB interface	3
1.6 Connect your device	5
1.6.1 Connect with USB	5
1.6.2 Connect with RS-232 Serial Port	5
1.7 Barcode preset parameters	5
1.8 Start-up, shutdown and restart	6
1.9 Maintenance	6
1.10 Reading skills	6
2.Command Instruction	8
2.1 barcode instructions explain	8
2.2 Serial port instructions explain	9
2.3 Instruction list	10
2.4 Quick instructions (HEX format)	11

3、 System setting	12
3.1 Mark setting	12
3.2 Setting Steps	12
3.2.1 Interface mode setting	13
3.2.2 Buzzer and LED setting	13
3.2.3 Baud rate setting	14
3.2.4 Serial port instructions response setting	14
3.2.5 Trigger scan and stop scan setting	15
3.2.6 Trigger scan model and reading mode setting	15
3.2.7 Same Barcode Scanning Interval setting	16
3.2.8 Scan time setting for key trigger scan mode	16
3.2.9 Scan time setting for serial command/auto scan mode	17
3.2.10 Case switching	18
3.2.11 auto sense mode setting	18
3.2.12 USB upload speed setting	19
3.2.13 Decode setting	19
3.2.14 Disable/Enable read all barcodes	20
3.2.15 Start character	21
3.2.16 Ending character setting	21
3.2.17 User-defined start character/ending character	23
Appendix 1 User-defined start character/ending character	24
Appendix 2 ASCII table	33
Appendix 3 barcode sample.....	37

1、Product Introduction

This user guide applies to E1005 and E1007, which identify 1D barcodes by red light scanning pattern, and apply the complete set of patent technology developed by Guangzhou YOKO Electron Co., Ltd. The scanners above are of strong identification capability, and support automatic continuous scanning mode with fast and flexible scanning speed.

In this chapter, we will introduce the instruction of scanner with pictures, please compare to the scanner you bought when reading this user guide, which is good for your understanding. This chapter applies to regular users, maintenance personnel, and software developers.

1.1 Main feature

* Complete independent research and development, possessing the complete set of patent, plug and play without the need to install driver.

* Wide voltage design to avoid the data can't be transmitted due to voltage fluctuation.

* 32-bit master chip equipped with patented software, the scanner can smoothly decode reflective, wrinkled, blurred, and colorful barcode, and can also normally scan in light and dark environment.

* Adopt all tantalum capacitors and anti-oxidation optical technology, avoiding the problem of sensitivity declining after long-term using.

1.2 Unpack your device

After you open the shipping carton containing the product, take the following steps:

- Take out the accessories from package.
- Check with the packing list to see if everything is complete and in good condition.

If there are any damaged or missing components, please keep the original package and contact your supplier for after-sales service.

1.3 Product display

1.3.1 External view

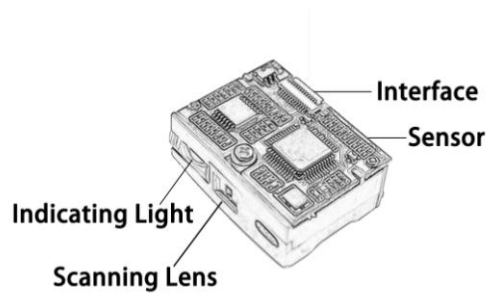

1.3.2 Dimension (mm)

Aerial view

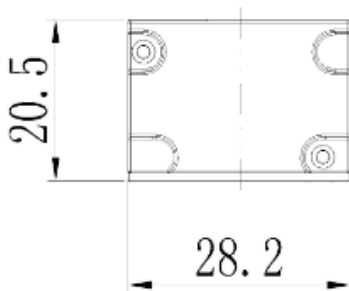

Side view

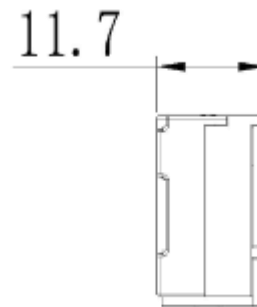

1.4 Communication port

The scanner must be connected to a host to operate. Host can be a PC, POS machine, intelligent terminal with USB or RS-232 interface.

USB

USB interface on host



RS-232

RS-232 interface on host



1.5 Interface description

Product standard interfaces are: RS232 (DB9 orifice), USB and Keyboard. Standard interface of different products are not the same, please confirm before purchase, other

interfaces can be customized according to customer needs.

1.5.1 Scan module interface CMOS

Interface NO.	Name	Type	Description
1	NC	Empty	Spare
2	VCC	DC power supply	DC3.3V or DC5V(depending on the module) \pm 5%
3	GND	Digital ground	GND
4	Rx	Input	Serial input port TTL level
5	Tx	output	Serial input port TTL level
6	USB_D-	Input / output	USB_D- signal
7	USB_D	Input / output	USB_D+ signal
8	NC	Empty	Spare
9	BPR	output	Buzzer output signal
10	LED	output	The light indicates successful decoding, and outputs low level 150ms
11	NC	Empty	Spare
12	TRIG	Input	Trigger to scan

1.5.2 Standard serial port (DB9)

NO.	function
1	Trigger(choose to connect)
2	Rx
3	Tx
5	GND
9	DC 5V(choose to connect)

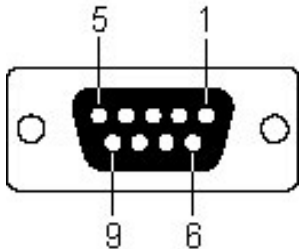

At the 1 pin of the serial port, when the pin receives low level of 10ms, it is equivalent to press the trigger button, then trigger to scan (this function is optional).

At the 6 pin of the serial port, only for trigger mode, after each trigger, if you do not recognize the bar code, the pin will output low level of 100ms (this function belongs to value-added service).

1.5.3 USB interface

No.	Function
	

1	VCC	
2	D-	
3	D+	
4	GND	

According to the actual situation can be divided into two types: usb hid keyboard and usb virtual serial port. When you connect the engine to the host via USB, you can enable the USB HID-KBW feature by scanning the bar code below; then the engine's transfer will be modeled as a USB keyboard input. The host receives the keys of the virtual keyboard.

1.6 Connect your device

1.6.1 Connect with USB



- 1: Connect the device interface of USB with scanner ;
- 3: Connect the host interface (USB interface) of USB with host computer.

1.6.2 Connect with RS-232 Serial Port



- 1: Connect the device interface of RS-232 serial port with scanner ;
- 2: Connect the RS-232 serial port with power adapter;
- 3: Connect the host interface (RS-232 interface) of the RS-232 serial port with host computer.

1.7 Barcode preset parameters

barcode type	read	effect test	effect test transmission	prefix /postfix code transmission postposition	minimum / maximum length	code ID
(EAN13 & UPC E)	√	√	√	x	13	A
EAN8	√	√	√	x	8	B
UPC A	√	√	√	x	12	C
CODABAR (NW-7)	√	-	√	-	4~70	E
CODE 39	√	-	√	-	3~50	F
CODE 93	√	√	√	x	1~80	G
INTERLEAVED	√	-	√	x	4~80	H
CODE 128	√	√	-	x	1~80	K

1、 "√" represents the default parameter is open, "-" denotes the default parameter is close, "X" means this parameter does not exist in the barcode type;

2、 "2" marked on the upper right corner of minimum / maximum length means bar length is fixed;

1.8 Start-up, shutdown and restart

Start-up: Connect host computer with scanner, which will automatically start-up and in working state.

Shutdown: Remove the data cable which is connected with scanner; remove the USB which is connected with host computer.

Restart: If the scanner crashes or doesn't respond, please switch it off and restart.

1.9 Maintenance

* The window must be kept clean, the supplier do not bear the guarantee responsibility due to the improper maintenance.

* Avoid the window being wear and tear or scratched by hard object

* Use the hairbrush to remove the stain on the window

* Clean the window with a soft cloth, such as lens cleaning cloth

* Spraying liquid onto the window is prohibited.

* Prohibit any cleaning solvents, except for the cleaning water.

1.10 Reading skills

If the barcode is small, it should be closer to the scanning window; if the barcode is large, it should be far away from the scanning window a little more, thus easier to be read correctly.

If the barcode is highly reflective (for example, the coated surface), you may need to tilt the barcode at an angle to successfully scan it.

Barcode scanning example:

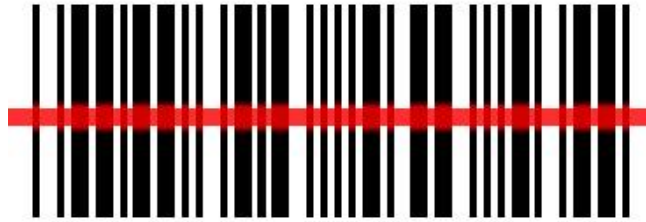

2.Command Instruction

2.1 barcode instructions explain

1、 Instruction barcodes use code 39 type Full-ASCII codes to design and print. The Command value in instruction barcodes is the same as serial port instructions.

2、 The description with an asterisk(*)means factory default。

(1) Scan: Enter setting “YSET”. After enter setting, if you don't scan any instruction barcodes in 30 seconds, the scanner will exit setting automatically.

(2) Scan: Change settings. You can scan one or multiple instruction barcodes

(3) Scan: Exit and saving changes “YEND”.

2.2 Serial port instructions explain

Table 2.2-1 Data format of serial port instructions

Length	Message Source	Message target	Reserve	Reserve	Command	beeper	Check Sum
--------	----------------	----------------	---------	---------	---------	--------	-----------

Table 2.2-2 Serial port instructions analysis

Field	Format	Sub-Field	Description
Length	1 Byte	Length	command length, not include Check Sum, maximum 0xFF
Message Source	1 Byte	0x04 = Host (PC or IPC); 0x31 = Decoder (barcode scanner)	Sources of command
Message target	1 Byte	0x04 = Host (PC 机或工控机) 0x31 = Decoder (barcode scanner)	command target address
Reserve	1Byte	reserved (0x00)	
Reserve	1Byte	reserved (0x00)	
Command	Variable number of bytes		
Beeper	1 Byte	0x31 = open 0xFF = close	If the buzzer is open
Check Sum	2 Byte		Check sum of message formatted as High byte low byte

Remark:

1、Check Sum:

Complement of the command sum, high byte is ahead, low byte is behind.

Check calculation method: all bits(not including two check bits) sum up, then inverse the result and plus 1

Example: Exit and save (0A 04 31 00 24 25 45 4E 44 FF) add up and equal : 02 5E,

Turn to binary (0000 0010 0101 1110), inverse calculate: 1111 1101 1010 0001, add 1 and get the check code (FD A2)。

2、When the command below which format is character(without "0X"as prefix, if you want use it as serial command, you need to converted them to ASCII which is Hexadecimal.

2.3 Instruction list

Table 2.3-1 instruction list

name	describe	instruction barcodes ¹	Serial port instructions ²	Serial port reply ³
YSET	Enter setting mode	√	×	×
YEND	Exit and save ⁶	√	√	√
TRIGGER_SCAN	Trigger scan	×	√	√+barcode ⁴
STOP_SCAN	Stop scanning	√	√	√
FACTORY_DEFAULTS	Restore factory setting	√	√	√
CUSTOM_DEFAULTS	Restore user setting	√	√	√
WR_CUSTOM_DEFAULTS	Write user-defined default	√	√	√
READ_REVISION	Read the batch version number	√	√	√+version ⁵
PARAM_MODIFY	Change parameters	√	√	√
OPEN_BEEPER	open buzzer	×	√	×
ACK	Shake hands	×	√	×

remark:

- 1、 Whether to support barcode instruction.
- 2、 Whether to support serial instruction.
- 3、 When allowed to answer, do the scanner need to answer the instruction which sent by serial port;
- 4、 When decode successfully, except for answer, the scanner will return the ASCII code of the barcode.
- 5、 When allowed to answer, the scanner will answer first then return the version number
- 6、 save setting。

2.4 Quick instructions (HEX format)

quick instructions must be used in below conditions: Message Source = 0x04 (PC or IPC);

Message target = 0x31 (Barcode scanner 0x31);

Beeper = 0xFF (close)。

quick instructions for PC or IPC to barcode scanner:

Table 2.4-1 Host to Decoder

function	instructions (HEX format)
Normal instruction:	
Save and exit (YEND)	0A 04 31 00 00 59 45 4e 44 FF FD 92
Trigger the scan (YLTK)	0A 04 31 00 00 59 4c 54 4b FF FD 7E
Stop scanning (YLSK)	0A 04 31 00 00 59 4c 53 4b FF FD 7F
Restore factory default (YDFK)	0A 04 31 00 00 59 44 46 4b FF FD 94
Restore user default (YDCK)	0A 04 31 00 00 59 44 43 4b FF FD 97
Write user default (YWCK)	0A 04 31 00 00 59 57 43 4b FF FD 84
Read the batch version number (YRVK)	0A 04 31 00 00 59 52 56 4b FF FD 76

Change parameters instructions:	
single trigger mode (F000)	0B 04 31 00 00 46 30 30 30 30 FF FD BB
continue scan mode (F001)	0B 04 31 00 00 46 30 30 30 31 FF FD BA
Not allowed Repeat reading (F0100)	0B 04 31 00 00 46 30 31 30 30 FF FD BA
allowed Repeat reading (F0101)	0B 04 31 00 00 46 30 31 30 31 FF FD B9
Enable/disable allowed Repeat reading (F0102)	0B 04 31 00 00 46 30 31 30 32 FF FD B8
TTL/RS232 output (A000)	0B 04 31 00 50 41 30 30 30 30 FF FD 70
USB HID Keyboard output (A0001)	0B 04 31 00 50 41 30 30 30 31 FF FD 6F
Don't need to answer (E000)	0B 04 31 00 00 45 30 30 30 30 FF FD BC
Need to answer (E0001)	0B 04 31 00 00 45 30 30 30 31 FF FD BB
Disable Read All barcode (I1000)	0B 04 31 00 00 49 31 30 30 30 FF FD B7
Enable Read All barcodes (I1001)	0B 04 31 00 00 49 31 30 30 31 FF FD B6

Table 2.4-2 Decoder to Host

function	instructions (HEX format)
Setting successful answer	07 31 04 01 01 06 FF FE BE
Setting failed answer	07 1 04 01 01 15 FF FE AF

3、 System setting

Option and function setting mainly through reading a series of special barcodes. In this chapter, we will provide you a detailed introduction of the options and functions available for user setting, and the corresponding setup code.

This method of setting the scanning is direct, easy to understand and user friendly.

3.1 Mark setting



3.2 Setting Steps

Read the "Enter setting" barcode to activate code setting function. Scanners can be set by reading one or more setting code.

Scan the "Exit setting" barcode to exit the setup code function. Scan the "Restore factory default setting" barcode to restore the factory setting.

Take the following setting steps:

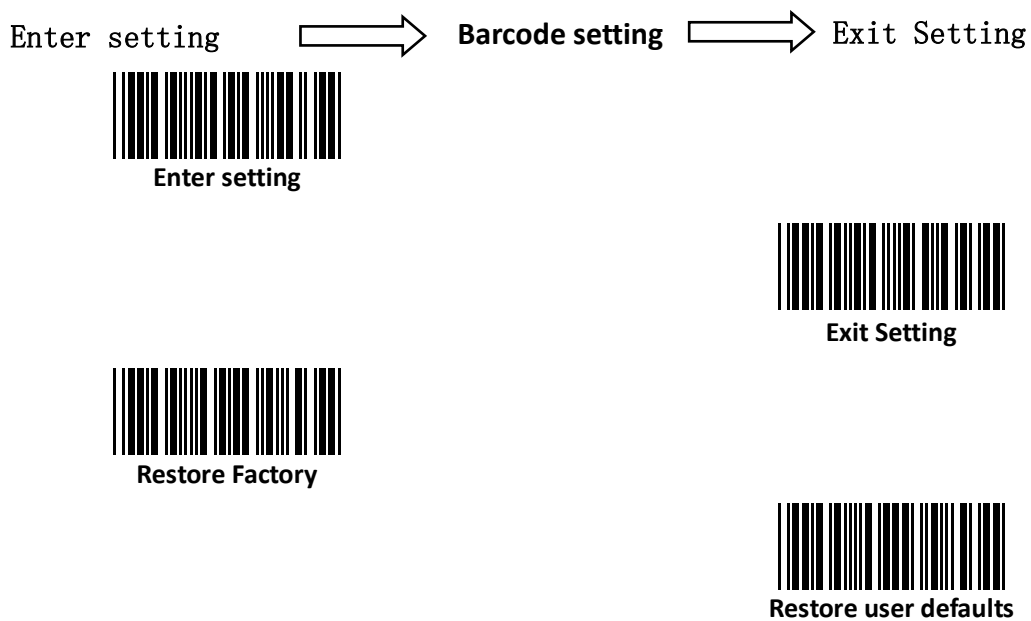

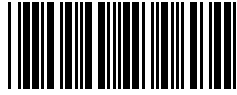

Setting user defaults

(Save current setting as user-defined defaults)



Read production batch version

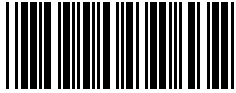

Read BOOTLOAD version

3.2.1 Interface mode setting

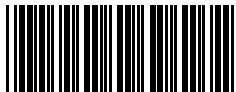

RS 232 MODEL



USBMODEL

3.2.2 Buzzer and LED setting

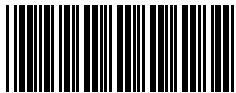

Shut down start voice



Open start voice (default)



Successful scanning sound off



Successful scanning sound on(default)



Buzze Volume low



Buzze Volume middle (default)



Volume high

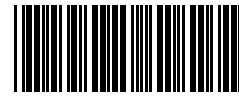

Successful setting sound off



Successful setting sound on (default)

3.2.3 Baud rate setting



2400 baud

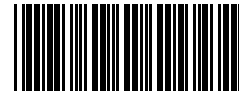

4800 baud

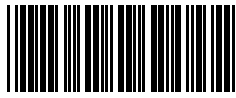

9600 baud (default)



19200 baud



38400 baud



57600 baud

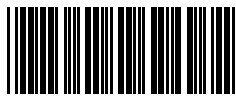

115200 baud

3.2.4 Serial port instructions response setting

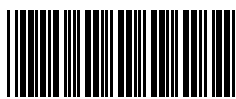

NO response (default)



response

3.2.5 Trigger scan and stop scan setting



Trigger scan



Stop scan

3.2.6 Trigger scan model and reading mode setting

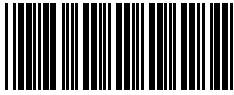

Single trigger scan model(default)

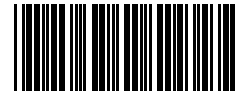

Continue scan model



Not allowed Repeat reading



allowed Repeat reading (default)



Enable/disable allowed
Repeat reading

3.2.7 Same Barcode Scanning Interval setting

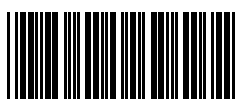

0ms (default)

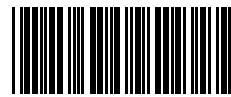

100ms

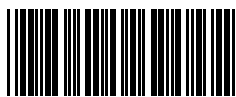

200ms

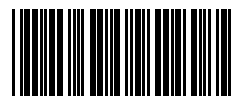

500ms



900ms



1000ms

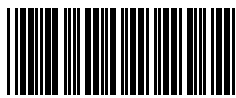

1500ms



2000ms



9900ms

3.2.8 Scan time setting for key trigger scan mode

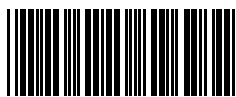

0ms (default)

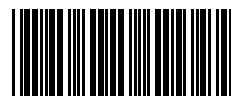

100ms

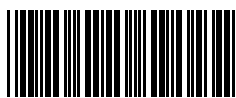

200ms

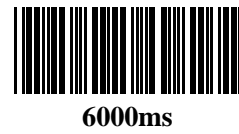
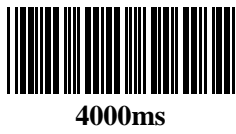
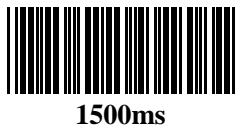

3.2.9 Scan time setting for serial command/auto scan mode



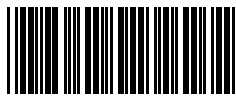

1000ms

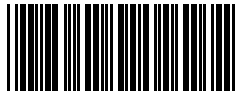

2000ms

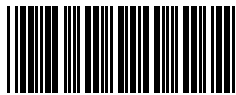

6000ms

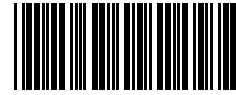

900ms

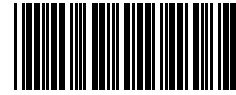

1500ms

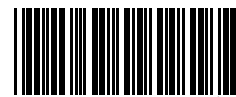

4000ms (default)

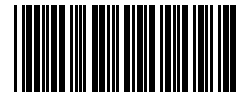

9900ms

3.2.10 Case switching

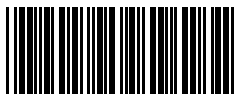

No case switching (default)



Lowercase switch to uppercase

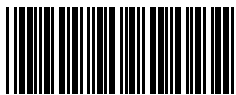

Uppercase switch to lowercase

3.2.11 auto sense mode setting

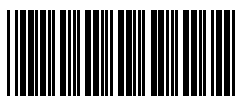

Disable (default)

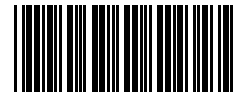

Enable



high sensitivity (default)

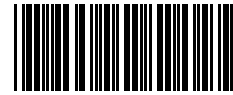

low sensitivity

3.2.12 USB upload speed setting

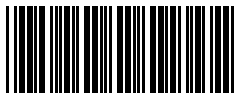

USB upload speed slow (default)

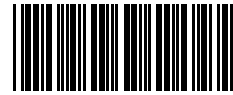

USB upload speed middle



USB upload speed fast

3.2.13 Decode setting



Disable Read (EAN)

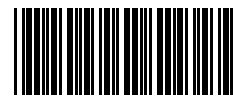

Enable Read (EAN) (default)

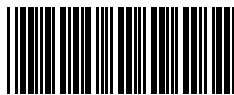

Disable Read (Codabar)

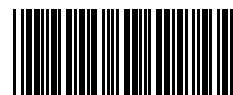

Enable Read (Codabar) (default)

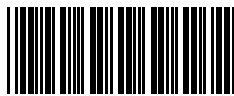

Disable Read (Code 93)



3.2.14 Disable/Enable read all barcodes



3.2.15 Start character



No start character (default)

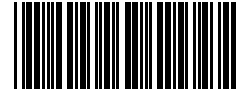

Space + barcode

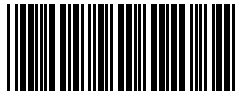

ID+barcode

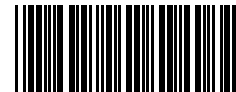

ID+ user-defined start character +
barcode

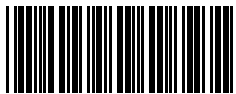

user-defined start character + ID +
barcode



user-defined start character + barcode

3.2.16 Ending character setting



No ending character (default)



0x0D as ending character



0x0A as ending character

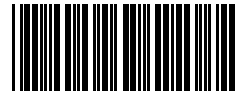

0x0D 0x0A as ending character

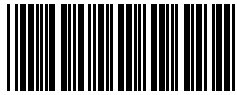

Tab(0x09)

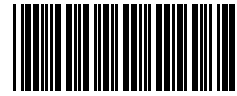

Tab(0x09) 0x0D

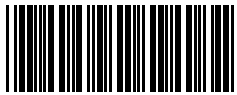

Barcode + user-defined ending character

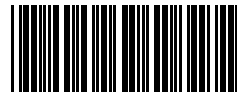

Barcode + user-defined ending character+0x0D

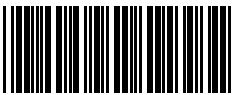

Barcode + user-defined ending character+0x0A

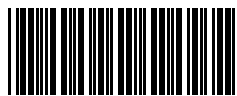

Barcode + user-defined ending character+0x0D 0x0A



Barcode + user-defined ending character + Tab (0x09)

3.2.17 User-defined start character/ending character



User-defined start character

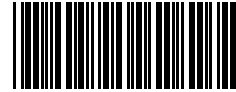

































User-defined ending character

remark: User-defined start character/ending character please refer to appendix 1





















Appendix





















Appendix 1 User-defined start character/ending character





















Control character	Hex	barcode
^@ (NULL)	YS00	
^A (SOH)	YS01	
^B (STX)	YS02	
^C (ETX)	YS03	
^D (EOT)	YS04	
^E (ENQ)	YS05	
^F (ACK)	YS06	
^G (BEL)	YS07	
^H (BS)	YS08	
^I (HTab)	YS09	
^J (LF)	YS0A	
^K (VTab)	YS0B	
^L (FF)	YS0C	
^M (CR)	YS0D	
^N (SO)	YS0E	
^O (SI)	YS0F	

















^P (DLE)	YS10	
^Q (DC1)	YS11	
^R (DC2)	YS12	
^S (DC3)	YS13	
^T (DC4)	YS14	
^U (NAK)	YS15	
^V (SYN)	YS16	
^W (ETB)	YS17	
^X (CAN)	YS18	
^Y (EM)	YS19	
^Z (SUB)	YS1A	
^[(ESC)	YS1B	
^\\ (FS)	YS1C	
^] (GS)	YS1D	
^^ (RS)	YS1E	
^_ (US)	YS1F	
SPC	YS20	

















character	Hex	barcode
!	YS21	
"	YS22	
#	YS23	
\$	YS24	
%	YS25	
&	YS26	
'	YS27	
(YS28	
)	YS29	
*	YS2A	
+	YS2B	
,	YS2C	
-	YS2D	
.	YS2E	
/	YS2F	
0	YS30	
1	YS31	
2	YS32	

3	YS33	
4	YS34	
5	YS35	
6	YS36	
7	YS37	
8	YS38	
9	YS39	
:	YS3A	
;	YS3B	
<	YS3C	
=	YS3D	
>	YS3E	
?	YS3F	
@	YS40	
A	YS41	
B	YS42	
C	YS43	
D	YS44	
E	YS45	
F	YS46	

G	YS47	
H	YS48	
I	YS49	
J	YS4A	
K	YS4B	
L	YS4C	
M	YS4D	
N	YS4E	
O	YS4F	
P	YS50	
Q	YS51	
R	YS52	
S	YS53	
T	YS54	
U	YS55	
V	YS56	
W	YS57	
X	YS58	
Y	YS59	
Z	YS5A	

[YS5B	
\	YS5C	
]	YS5D	
^	YS5E	
_	YS5F	
`	YS60	
a	YS61	
b	YS62	
c	YS63	
d	YS64	
e	YS65	
f	YS66	
g	YS67	
h	YS68	
i	YS69	
j	YS6A	
k	YS6B	
l	YS6C	
m	YS6D	
n	YS6E	

o	YS6F	
p	YS70	
q	YS71	
r	YS72	
s	YS73	
t	YS74	
u	YS75	
v	YS76	
w	YS77	
x	YS78	
y	YS79	
z	YS7A	
{	YS7B	
	YS7C	
}	YS7D	
~	YS7E	
DEL	YS7F	

Function keys	Hex	barcode
F1	YS80	
F2	YS81	
F3	YS82	
F4	YS83	
F5	YS84	
F6	YS85	
F7	YS86	
F8	YS87	
F9	YS88	
F10	YS89	
F11	YS8A	
F12	YS8B	
Backspace	YS8C	
Tab	YS8D	
Return (ENTER)	YS8E	
Enter (Numeric Keypad)	YS8F	

Esc	YS90	
Arrow Down	YS91	
Arrow up	YS92	
Arrow right	YS93	
Arrow left	YS94	
Insert	YS95	
Home	YS96	
End	YS97	
Page up	YS98	
Page down	YS99	
Left Shift	YS9A	
Left Ctrl	YS9B	
Left Alt	YS9C	
Left GUI	YS9D	
Right Shift	YS9E	
Right Ctrl	YS9F	
Right Alt	YSA0	
Right GUI	YSA1	
Caps Lock	YSA2	

Appendix 2 ASCII table

Decimal	Octal	Hexadecimal	character	description
0	0	00	NUL	
1	1	01	SOH	start of header
2	2	02	STX	start of text
3	3	03	ETX	end of text
4	4	04	EOT	end of transmission
5	5	05	ENQ	enquiry
6	6	06	ACK	acknowledge
7	7	07	BEL	bell
8	10	08	BS	backspace
9	11	09	HT	horizontal tab
10	12	0A	LF	line feed
11	13	0B	VT	vertical tab
12	14	0C	FF	form feed
13	15	0D	CR	carriage return
14	16	0E	SO	shift out
15	17	0F	SI	shift in
16	20	10	DLE	data link escape
17	21	11	DC1	no assignment, but usually XON
18	22	12	DC2	
19	23	13	DC3	no assignment, but usually XOFF
20	24	14	DC4	
21	25	15	NAK	negative acknowledge
22	26	16	SYN	synchronous idle
23	27	17	ETB	end of transmission block
24	30	18	CAN	cancel
25	31	19	EM	end of medium
26	32	1A	SUB	substitute
27	33	1B	ESC	escape
28	34	1C	FS	file separator
29	35	1D	GS	group separator
30	36	1E	RS	record separator
31	37	1F	US	unit separator
32	40	20	SPC	space
33	41	21	!	
34	42	22	"	









35	43	23	#	
36	44	24	\$	
37	45	25	%	
38	46	26	&	
39	47	27	'	
40	50	28	(
41	51	29)	
42	52	2A	*	
43	53	2B	+	
44	54	2C	,	
45	55	2D	-	
46	56	2E	.	
47	57	2F	/	
48	60	30	0	
49	61	31	1	
50	62	32	2	
51	63	33	3	
52	64	34	4	
53	65	35	5	
54	66	36	6	
55	67	37	7	
56	70	38	8	
57	71	39	9	
58	72	3A	:	
59	73	3B	;	
60	74	3C	<	
61	75	3D	=	
62	76	3E	>	
63	77	3F	?	
64	100	40	@	
65	101	41	A	
65	101	41	A	
66	102	42	B	
67	103	43	C	
68	104	44	D	
69	105	45	E	
70	106	46	F	
71	107	47	G	
72	110	48	H	

73	111	49	I	
74	112	4A	J	
75	113	4B	K	
76	114	4C	L	
77	115	4D	M	
78	116	4E	N	
79	117	4F	O	
80	120	50	P	
81	121	51	Q	
82	122	52	R	
83	123	53	S	
84	124	54	T	
85	125	55	U	
86	126	56	V	
87	127	57	W	
88	130	58	X	
89	131	59	Y	
90	132	5A	Z	
91	133	5B	[
92	134	5C	\	
93	135	5D]	
94	136	5E	^	
95	137	5F	_	
96	140	60	`	
97	141	61	a	
98	142	62	b	
99	143	63	c	
100	144	64	d	
101	145	65	e	
102	146	66	f	
103	147	67	g	
104	150	68	h	
105	151	69	i	
106	152	6A	j	
107	153	6B	k	
108	154	6C	l	
109	155	6D	m	
110	156	6E	n	
111	157	6F	o	

112	160	70	p	
113	161	71	q	
114	162	72	r	
115	163	73	s	
116	164	74	t	
117	165	75	u	
118	166	76	v	
119	167	77	w	
120	170	78	x	
121	171	79	y	
122	172	7A	z	
123	173	7B	{	
124	174	7C		
125	175	7D	}	
126	176	7E	~	
127	177	7F	DEL	delete
128	200	80	F1	
129	201	81	F2	
130	202	82	F3	
131	203	83	F4	
132	204	84	F5	
133	205	85	F6	
134	206	86	F7	
135	207	87	F8	
136	210	88	F9	
137	211	89	F10	
138	212	8A	F11	
139	213	8B	F12	
140	214	8C	Backspace	
141	215	8D	Tab	
142	216	8E	Return	
143	217	8F	Enter	
144	220	90	Esc	
145	221	91	Arrow Down	
146	222	92	Arrow up	
147	223	93	Arrow right	
148	224	94	Arrow left	
149	225	95	Insert	
150	226	96	Home	

151	227	97	End	
152	230	98	Page up	
153	231	99	Page down	
154	232	9A	Left Shift	
155	233	9B	Left Ctrl	
156	234	9C	Left Alt	
157	235	9D	Left GUI	
158	236	9E	Right Shift	
159	237	9F	Right Ctrl	
160	240	A0	Right Alt	
161	241	A1	Right GUI	
162	242	A2	Caps Lock	

Appendix 3 barcode sample

name	Barcode sample	remarks
EAN13	 9 780131 103627	
UPC-A	 0 71589 81230 8	
EAN8	 6537 8823	
UPC-E	 0 123456 5	Default data: 1234565
Codabar	 01235	Encoded data: c01235d
Code93	 Code 93	
Code39(Regular)	 CODE39	
Code 39(FullASCII)	 Code 39	Encoded data: *Code 39



Guangzhou Yoko Electron Co., Ltd.

Address: NO.4, Changrong Road, Shabu Industrial Zone,
Huangpu District, Guangzhou,China

Tel: 020-8206 5617

Fax: 020-8206 5420

Website: <http://www.chinayoko.com/>



