

Description

The Arduino UNO R4 Minima (from here on referred to as UNO R4 Minima) is the first UNO board to feature a 32-bit microcontroller. It features a RA4M1 series microcontroller from Renesas (R7FA4M1AB3CFM#AA0), which embeds a 48 MHz Arm® Cortex®-M4 microprocessor. The UNO R4's memory is larger than its predecessors, with 256 kB flash, 32 kB SRAM and 8 kB data memory (EEPROM).

The UNO R4 Minima board's operating voltage is 5 V, making it hardware compatible with UNO form factor accessories with the same operating voltage. Shields designed for previous UNO revisions are therefore safe to use with this board but are not guaranteed to be software compatible due to the change of microcontroller.

Target areas:

Maker, beginner, education



Features

- **R7FA4M1AB3CFM#AA0**
 - 48 MHz Arm® Cortex®-M4 microprocessor with a floating point unit (FPU)
 - 5 V operating voltage
 - Real-time Clock (RTC)
 - Memory Protection Unit (MPU)
 - Digital Analog Converter (DAC)
- **Memory**
 - 256 kB Flash Memory
 - 32 kB SRAM
 - 8 kB Data Memory (EEPROM)
- **Pins**
 - 14x digital pins (GPIO), D0-D13
 - 6x analog input pins (ADC), A0-A5
 - 6x PWM pins: D3,D5,D6,D9,D10,D11
- **Peripherals**
 - Capacitive Touch Sensing Unit (CTSU)
 - USB 2.0 Full-Speed Module (USBFS)
 - up to 14-bit ADC
 - up to 12-bit DAC
 - Operational Amplifier (OPAMP)
- **Power**
 - Recommended input voltage (VIN) is 6-24 V
 - 5 V operating voltage
 - Barrel jack connected to VIN pin
 - Power via USB-C® at 5 V
 - Schottky diodes for overvoltage and reverse polarity protection
- **Communication**
 - 1x UART (pin D0, D1)
 - 1x SPI (pin D10-D13, ICSP header)
 - 1x I2C (pin A4, A5, SDA, SCL)
 - 1x CAN (pin D4, D5, external transceiver is required)



CONTENTS

1 The Board	4
1.1 Application Examples	4
1.2 Related Products	4
2 Recommended Operating Conditions	5
3 Block Diagram	6
4 Board Topology	7
4.1 Front View	7
4.2 Back View	8
5 Microcontroller (R7FA4M1AB3CFM#AA0)	8
6 USB Connector	9
7 Digital Analog Converter (DAC)	9
8 Power Options	9
8.1 Power Tree	9
8.2 Pin Voltage	10
8.3 Pin Current	10
9 Pinout	11
9.1 Analog	12
9.2 Digital	12
9.3 ICSP	13
9.4 SWD/JTAG	13
10 Mounting Holes And Board Outline	13
11 Board Operation	14
11.1 Getting Started - IDE	14
11.2 Getting Started - Arduino Web Editor	14
11.3 Getting Started - Arduino IoT Cloud	14
11.4 Online Resources	14
11.5 Board Recovery	14
12 Declaration of Conformity CE DoC (EU)	15
13 Declaration of Conformity to EU RoHS & REACH 211 01/19/2021	3
14 Conflict Minerals Declaration	16
15 FCC Caution	16
16 Company Information	17
17 Reference Documentation	17
18 Change Log	17



1 The Board

1.1 Application Examples

The UNO R4 Minima is the first UNO series 32-bit development board, being previously based on 8-bit AVR microcontrollers. There are thousands of guides, tutorials and books written about the UNO board, where UNO R4 Minima continues its legacy.

The board features the standard 14 digital I/O ports, 6 analog channels, dedicated pins for I2C, SPI and UART connections. Compared to its predecessors the board has a much larger memory: 8 times more flash memory (256 kB) and 16 times more SRAM (32 kB).

Entry level projects: If this is your first project within coding and electronics, the UNO R4 Minima is a good fit. It is easy to get started with and has a lot of online documentation (both official + 3rd party).

Easy power management: the UNO R4 Minima has a barrel jack connector and supports input voltages from 6-24 V. This connector is widely popular and removes the need for additional circuitry required to step down the voltage.

Cross compatibility: the UNO form factor automatically makes it compatible with hundreds of existing third-party shields and other accessories.

1.2 Related Products

- UNO R3
- UNO R3 SMD
- UNO R4 WiFi



Rating

2 Recommended Operating Conditions

Symbol	Description	Min	Typ	Max	Unit
V _{IN}	Input voltage from VIN pad / DC Jack	6	7.0	24	V
V _{USB}	Input voltage from USB connector	4.8	5.0	5.5	V
T _{OP}	Operating Temperature	-40	25	85	°C

Functional Overview

3 Block Diagram

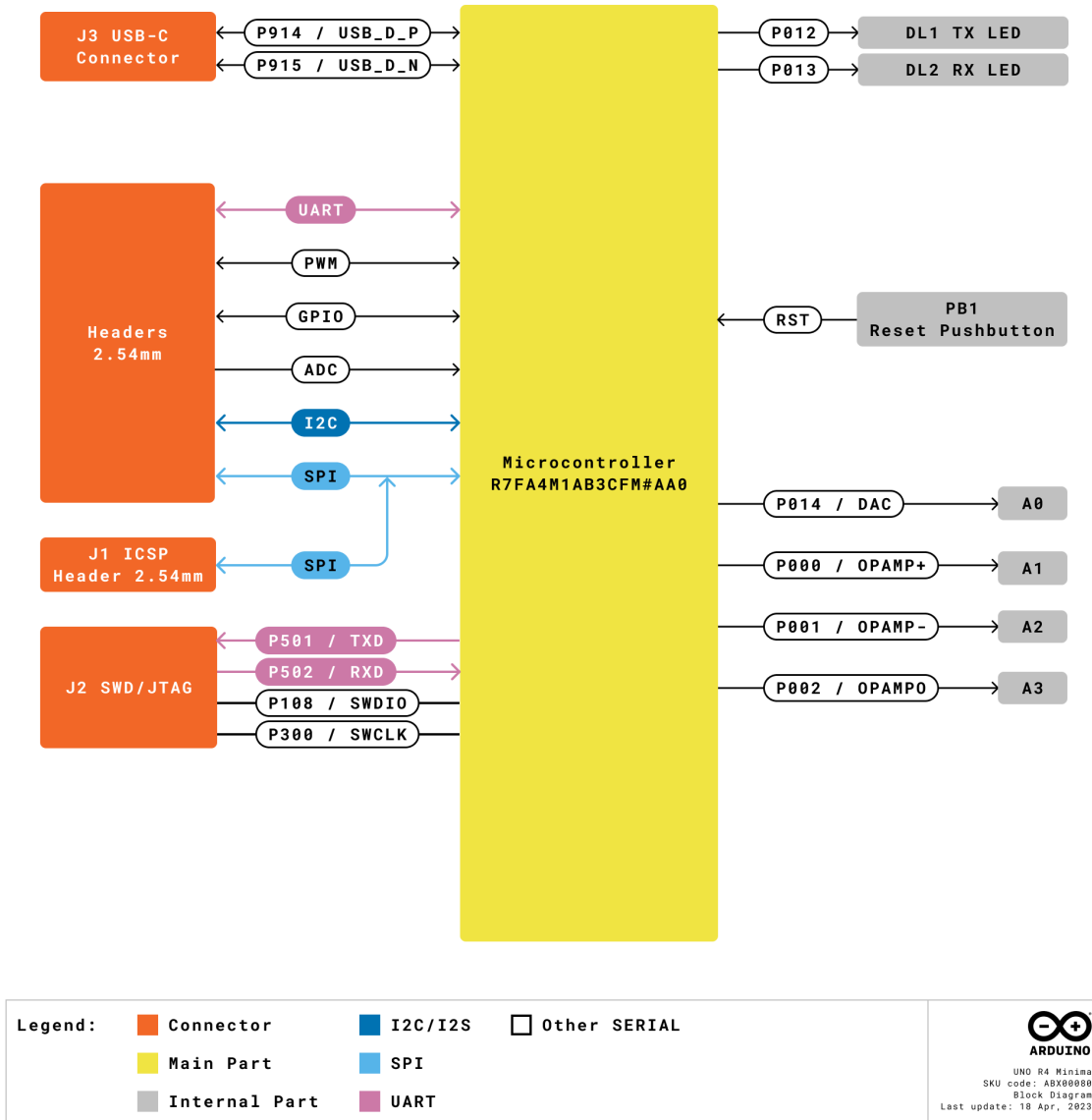

Arduino R4 Minima Block Diagram

4 Board Topology

4.1 Front View

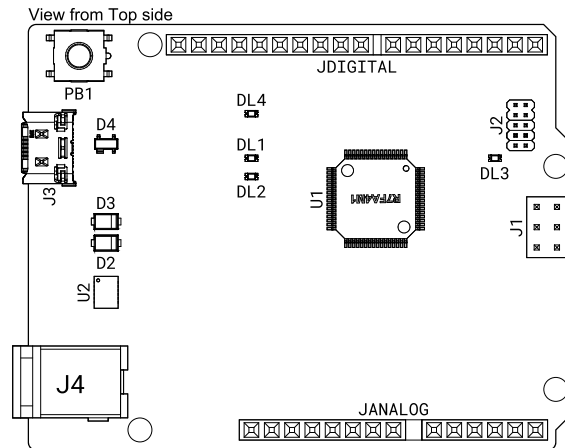

Top View of Arduino UNO R4 Minima

Ref.	Description	Ref.	Description
U1	R7FA4M1AB3CFM#AA0 Microcontroller IC	J4	DC Jack
U2	ISL854102FRZ-T Buck Converter	DL1	LED TX (serial transmit)
PB1	RESET Button	DL2	LED RX (serial receive)
JANALOG	Analog input/output headers	DL3	LED Power
JDIGITAL	Digital input/output headers	DL4	LED SCK (serial clock)
J1	ICSP header (SPI)	D2	PMEG6020AELRX Schottky Diode
J2	SWD/JTAG Connector	D3	PMEG6020AELRX Schottky Diode
J3	CX90B-16P USB-C® connector	D4	PRTR5V0U2X,215 ESD Protection

4.2 Back View

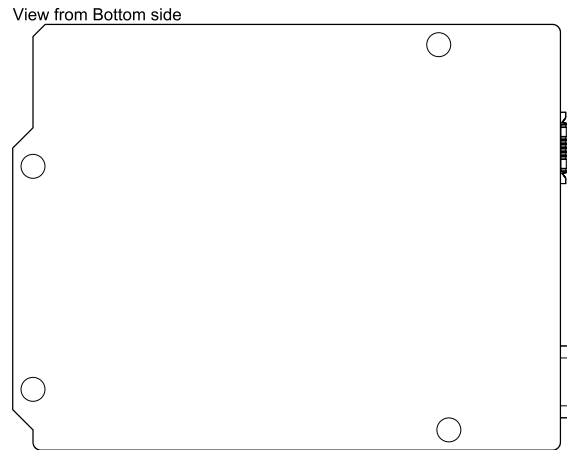

Back View of Arduino R4 Minima

5 Microcontroller (R7FA4M1AB3CFM#AA0)

The UNO R4 Minima is based on the 32-bit RA4M1 series microcontroller, **R7FA4M1AB3CFM#AA0**, from Renesas, which uses a 48 MHz Arm® Cortex®-M4 microprocessor with a floating point unit (FPU).

On the UNO R4 Minima, the operating voltage is fixed at 5 V to be fully retro compatible with shields, accessories & circuits originally designed for older UNO revisions.

The R7FA4M1AB3CFM#AA0 features:

- 256 kB flash / 32 kB SRAM / 8 kB data flash (EEPROM)
- Real-time Clock (RTC)
- 4x Direct Memory Access Controller (DMAC)
- up to 14-bit ADC
- up to 12-bit DAC
- OPAMP
- 1x CAN bus

For more technical details on this microcontroller, visit Renesas - RA4M1 series.



6 USB Connector

The UNO R4 Minima has one USB-C® port, used to power and program your board as well as send & receive serial communication.

Note: You should not power the board with more than 5 V via the USB-C® port.

7 Digital Analog Converter (DAC)

The UNO R4 Minima has a DAC with up to 12-bit resolution attached to the A0 analog pin. A DAC is used to convert a digital signal to an analog signal.

8 Power Options

Power can either be supplied via the VIN pin, the barrel jack, or via USB-C® connector. If power is supplied via VIN, the ISL854102FRZ buck converter steps the voltage down to 5 V.

The VUSB, barrel jack connector and VIN pins are connected to the ISL854102FRZ buck converter, with Schottky diodes in place for reverse polarity & overvoltage protection respectively.

Power via USB supplies about ~4.7 V (due to Schottky drop) to the RA4M1 microcontroller.

8.1 Power Tree

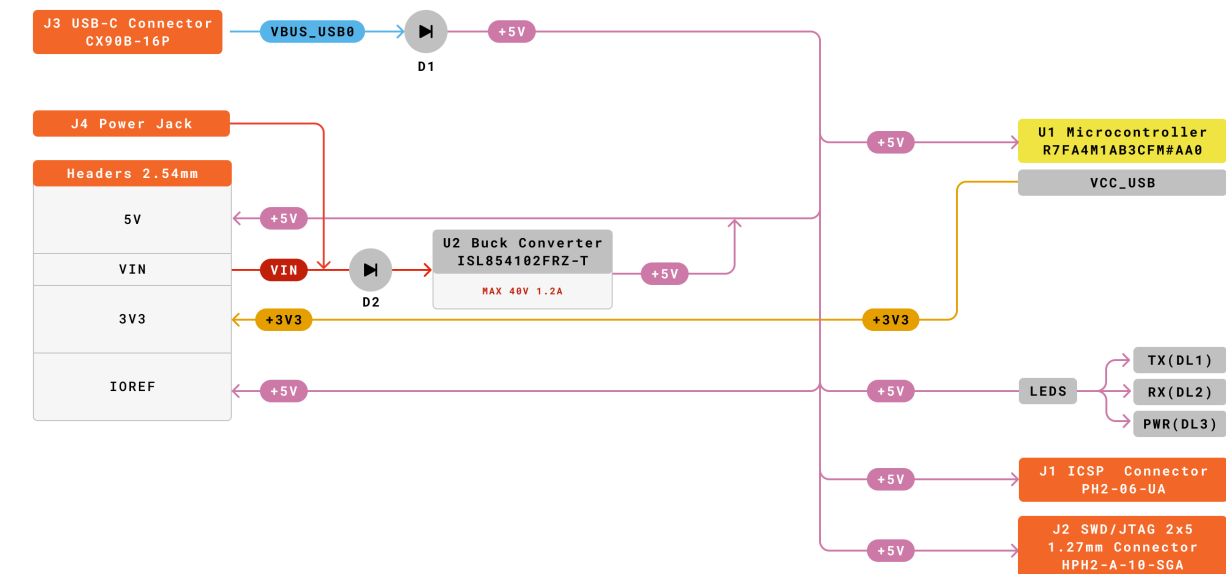

Legend:	Connector	+3V3
VIN	Main Part	+5V
VBUS	Internal Part	

UNO R4 Minima
SKU code: ABX00888
Power Tree
Last update: 18 Apr, 2023

Arduino UNO R4 Minima power tree.



8.2 Pin Voltage

The UNO R4 Minima operates on 5 V, as does all pins on this board except for the **3.3V pin**. This pin draws power from the VCC_USB pin on the R7FA4M1AB3CFM#AA0, and is not connected to the buck converter.

8.3 Pin Current

The GPIOs on the R7FA4M1AB3CFM#AA0 microcontroller can handle up to **8 mA**. Never connect devices that draw higher current directly to a GPIO.

In case you need to power external devices that require more power, e.g. servo motors, use an external power supply.



Mechanical Information

9 Pinout

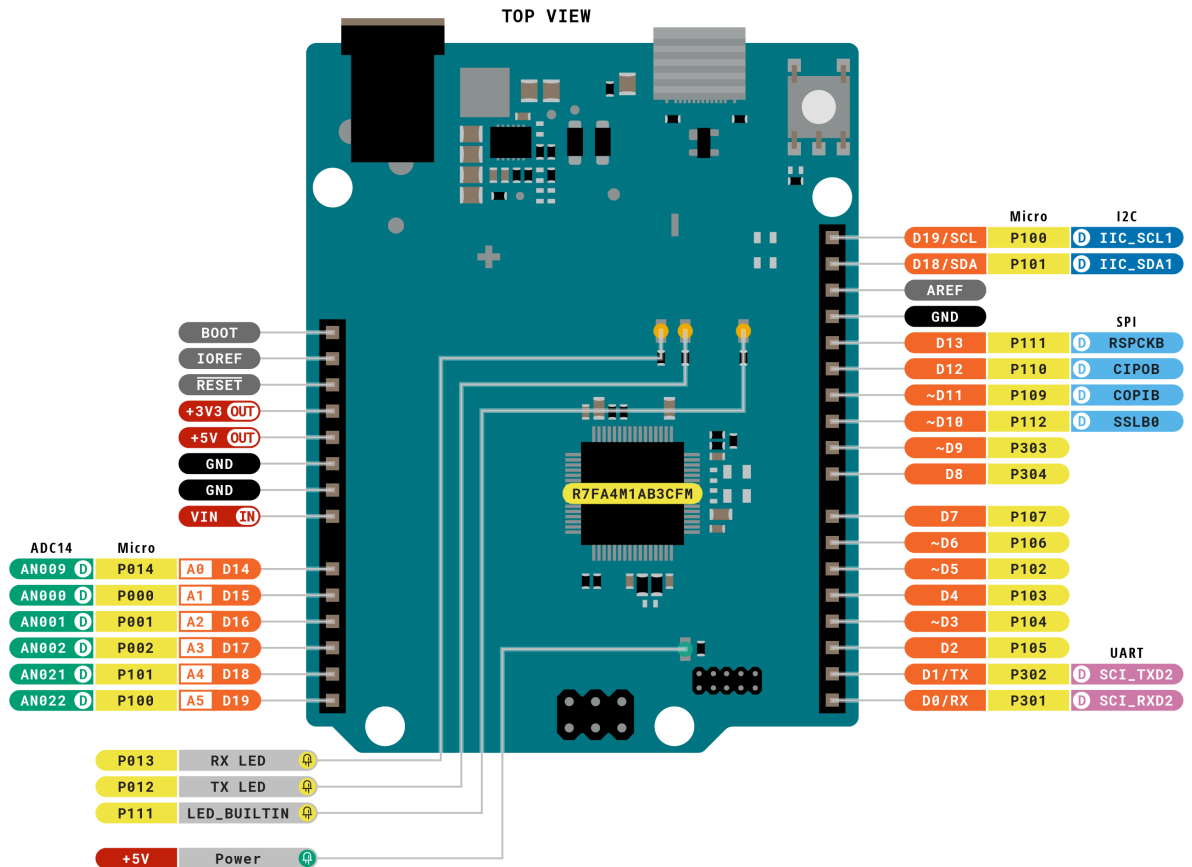

Legend:	■ Digital	■ I2C	 Other SERIAL
■ Power	 Analog	■ SPI	■ Analog
■ Ground	■ Main Part	■ UART/USART	 PWM/Timer



ARDUINO
 ARDUINO UNO R4 MINIMA
 SKU code: ABX00080
 Pinout
 Last update: 16 Jun, 2023

Pinout for UNO R4 Minima.



9.1 Analog

Pin	Function	Type	Description
1	BOOT	MD	Mode selection
2	IOREF	IOREF	Reference for digital logic V - connected to 5 V
3	Reset	Reset	Reset
4	+3V3	Power	+3V3 Power Rail
5	+5V	Power	+5V Power Rail
6	GND	Power	Ground
7	GND	Power	Ground
8	VIN	Power	Voltage Input
9	A0	Analog	Analog input 0 / DAC
10	A1	Analog	Analog input 1 / OPAMP+
11	A2	Analog	Analog input 2 / OPAMP-
12	A3	Analog	Analog input 3 / OPAMPOut
13	A4	Analog	Analog input 4 / I ² C Serial Datal (SDA)
14	A5	Analog	Analog input 5 / I ² C Serial Clock (SCL)

9.2 Digital

Pin	Function	Type	Description
1	SCL	Digital	I ² C Serial Clock (SCL)
2	SDA	Digital	I ² C Serial Datal (SDA)
3	AREF	Digital	Analog Reference Voltage
4	GND	Power	Ground
5	D13/SCK	Digital	GPIO 13 / SPI Clock
6	D12/CIPO	Digital	GPIO 12 / SPI Controller In Peripheral Out
7	D11/COPI	Digital	GPIO 11 (PWM) / SPI Controller Out Peripheral In
8	D10/CS	Digital	GPIO 10 (PWM) / SPI Chip Select
9	D9	Digital	GPIO 9 (PWM~)
10	D8	Digital	GPIO 8
11	D7	Digital	GPIO 7
12	D6	Digital	GPIO 6 (PWM~)
13	D5/CANRX0	Digital	GPIO 5 (PWM~) / CAN Transmitter (TX)
14	D4/CANTX0	Digital	GPIO 4 / CAN Receiver (RX)
15	D3	Digital	GPIO 3 (PWM~)
16	D2	Digital	GPIO 2
17	D1/TX0	Digital	GPIO 1 / Serial 0 Transmitter (TX)
18	D0/TX0	Digital	GPIO 0 / Serial 0 Receiver (RX)



9.3 ICSP

Pin	Function	Type	Description
1	CIPO	Internal	Controller In Peripheral Out
2	+5V	Internal	Power Supply of 5 V
3	SCK	Internal	Serial Clock
4	COPI	Internal	Controller Out Peripheral In
5	RESET	Internal	Reset
6	GND	Internal	Ground

9.4 SWD/JTAG

Pin	Function	Type	Description
1	+5V	Internal	Power Supply of 5 V
2	SWDIO	Internal	Data I/O pin
3	GND	Internal	Ground
4	SWCLK	Internal	Clock Pin
5	GND	Internal	Ground
6	NC	Internal	Not connected
7	RX	Internal	Serial Receiver
8	TX	Internal	Serial Transmitter
9	GND	Internal	Ground
10	NC	Internal	Not connected

10 Mounting Holes And Board Outline

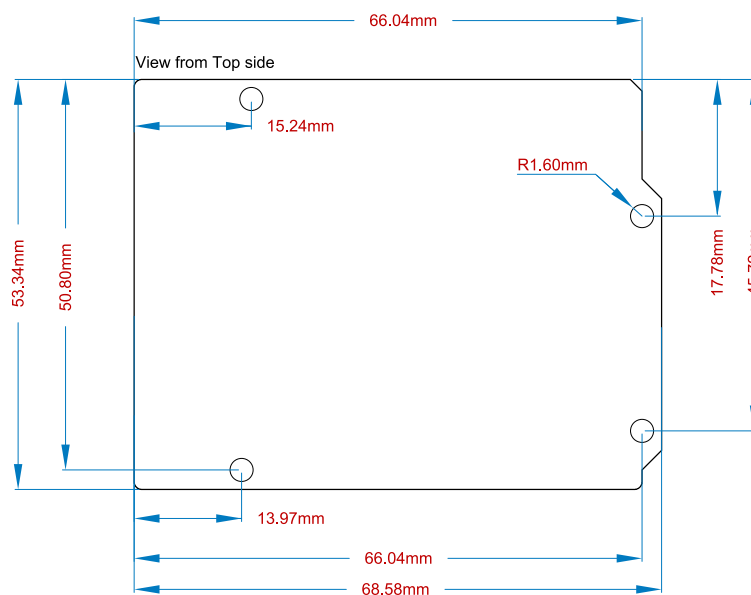



11 Board Operation

11.1 Getting Started - IDE

If you want to program your UNO R4 Minima while offline you need to install the Arduino® Desktop IDE **[1]**. To connect the UNO R4 Minima to your computer, you will need a Type-C® USB cable, which can also provide power to the board, as indicated by the LED (DL1).

11.2 Getting Started - Arduino Web Editor

All Arduino boards, including this one, work out-of-the-box on the Arduino Web Editor **[2]**, by just installing a simple plugin.

The Arduino Web Editor is hosted online, therefore it will always be up-to-date with the latest features and support for all boards. Follow **[3]** to start coding on the browser and upload sketches onto your board.

11.3 Getting Started - Arduino IoT Cloud

All Arduino IoT enabled products are supported on Arduino IoT Cloud which allows you to log, graph and analyze sensor data, trigger events, and automate your home or business.

11.4 Online Resources

Now that you have gone through the basics of what you can do with the board you can explore the endless possibilities it provides by checking exciting projects on Arduino Project Hub **[4]**, the Arduino Library Reference **[5]**, and the online store **[6]**; where you will be able to complement your board with sensors, actuators and more.

11.5 Board Recovery

All Arduino boards have a built-in bootloader which allows flashing the board via USB. In case a sketch locks up the processor and the board is not reachable anymore via USB, it is possible to enter bootloader mode by double-tapping the reset button right after the power-up.



Certifications

12 Declaration of Conformity CE DoC (EU)

We declare under our sole responsibility that the products above are in conformity with the essential requirements of the following EU Directives and therefore qualify for free movement within markets comprising the European Union (EU) and European Economic Area (EEA).

13 Declaration of Conformity to EU RoHS & REACH 211 01/19/2021

Arduino boards are in compliance with RoHS 2 Directive 2011/65/EU of the European Parliament and RoHS 3 Directive 2015/863/EU of the Council of 4 June 2015 on the restriction of the use of certain hazardous substances in electrical and electronic equipment.

Substance	Maximum Limit (ppm)
Lead (Pb)	1000
Cadmium (Cd)	100
Mercury (Hg)	1000
Hexavalent Chromium (Cr6+)	1000
Poly Brominated Biphenyls (PBB)	1000
Poly Brominated Diphenyl ethers (PBDE)	1000
Bis(2-Ethylhexyl} phthalate (DEHP)	1000
Benzyl butyl phthalate (BBP)	1000
Dibutyl phthalate (DBP)	1000
Diisobutyl phthalate (DIBP)	1000

Exemptions : No exemptions are claimed.

Arduino Boards are fully compliant with the related requirements of European Union Regulation (EC) 1907 /2006 concerning the Registration, Evaluation, Authorization and Restriction of Chemicals (REACH). We declare none of the SVHCs (<https://echa.europa.eu/web/guest/candidate-list-table>), the Candidate List of Substances of Very High Concern for authorization currently released by ECHA, is present in all products (and also package) in quantities totaling in a concentration equal or above 0.1%. To the best of our knowledge, we also declare that our products do not contain any of the substances listed on the "Authorization List" (Annex XIV of the REACH regulations) and Substances of Very High Concern (SVHC) in any significant amounts as specified by the Annex XVII of Candidate list published by ECHA (European Chemical Agency) 1907 /2006/EC.



14 Conflict Minerals Declaration

As a global supplier of electronic and electrical components, Arduino is aware of our obligations with regards to laws and regulations regarding Conflict Minerals, specifically the Dodd-Frank Wall Street Reform and Consumer Protection Act, Section 1502. Arduino does not directly source or process conflict minerals such as Tin, Tantalum, Tungsten, or Gold. Conflict minerals are contained in our products in the form of solder, or as a component in metal alloys. As part of our reasonable due diligence Arduino has contacted component suppliers within our supply chain to verify their continued compliance with the regulations. Based on the information received thus far we declare that our products contain Conflict Minerals sourced from conflict-free areas.

15 FCC Caution

Any Changes or modifications not expressly approved by the party responsible for compliance could void the user's authority to operate the equipment.

This device complies with part 15 of the FCC Rules. Operation is subject to the following two conditions:

- (1) This device may not cause harmful interference
- (2) this device must accept any interference received, including interference that may cause undesired operation.

FCC RF Radiation Exposure Statement:

1. This Transmitter must not be co-located or operating in conjunction with any other antenna or transmitter.
2. This equipment complies with RF radiation exposure limits set forth for an uncontrolled environment.
3. This equipment should be installed and operated with a minimum distance of 20 cm between the radiator & your body.

English: User manuals for licence-exempt radio apparatus shall contain the following or equivalent notice in a conspicuous location in the user manual or alternatively on the device or both. This device complies with Industry Canada licence-exempt RSS standard(s). Operation is subject to the following two conditions:

- (1) this device may not cause interference
- (2) this device must accept any interference, including interference that may cause undesired operation of the device.

French: Le présent appareil est conforme aux CNR d'Industrie Canada applicables aux appareils radio exempts de licence. L'exploitation est autorisée aux deux conditions suivantes :

- (1) l' appareil n' doit pas produire de brouillage
- (2) l' utilisateur de l' appareil doit accepter tout brouillage radioélectrique subi, même si le brouillage est susceptible d' en compromettre le fonctionnement.

IC SAR Warning:

English This equipment should be installed and operated with a minimum distance of 20 cm between the radiator and your body.



French: Lors de l'installation et de l'exploitation de ce dispositif, la distance entre le radiateur et le corps est d'au moins 20 cm.

Important: The operating temperature of the EUT can't exceed 85 °C and shouldn't be lower than -40 °C.

Hereby, Arduino S.r.l. declares that this product is in compliance with essential requirements and other relevant provisions of Directive 201453/EU. This product is allowed to be used in all EU member states.

16 Company Information

Company name	Arduino SRL
Company Address	Via Andrea Appiani, 25 - 20900 MONZA Italy)

17 Reference Documentation

Ref	Link
Arduino IDE (Desktop)	https://www.arduino.cc/en/Main/Software
Arduino IDE (Cloud)	https://create.arduino.cc/editor
Cloud IDE Getting Started	https://docs.arduino.cc/cloud/web-editor/tutorials/getting-started/getting-started-web-editor
Arduino Project Hub	https://create.arduino.cc/projecthub?by=part&part_id=11332&sort=trending
Library Reference	https://github.com/arduino-libraries/
Online Store	https://store.arduino.cc/

18 Change Log

Date	Changes
06/19/2023	Release